

FRONT DOOR HANDLES

| General catalogue



GENERAL CATALOGUE

FRONT DOOR HANDLES AND ACCESSORIES



SURFACES | COLOURS | 4

FRONT DOOR HANDLES

STANDARD | 6

CLASSIC DESIGN | 24

MODERN DESIGN | 32

TECHNOLOGY | 46

RENOVATION | 50

FASTENING | 56

ESCUTCHEONS | 62

HOUSE NUMBERS | ACCESSORIES | 66

INDEX | 68

SURFACES

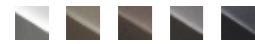

In addition to the very popular mirror-polished and brushed stainless steel standard surfaces, we can also offer other surfaces on request.

→ **PVD coating**

e.g. shiny gold, shiny chrome

→ **Powder coating**

Black mat (.0224) is standard and remains one of the most popular finishes for our front door handles. With the new colours *covered brass (.0284)*, *chilled copper (.0283)* and *mellow titanium (.0285)*, we are supplementing our standard surfaces for front door handles with a subtle, warm colour palette.

There are virtually no limits to the choice of powder coating colours.

All handles with a matt black finish (**.0224) can be powder-coated in any other colour.**

Simply ask us for your desired colour.

→ **Others on request**

It goes without saying that we pay strict attention to the surface coating to ensure that all surfaces fully meet the high requirements for outdoor use.

All surfaces are available on request for almost all push handle models.

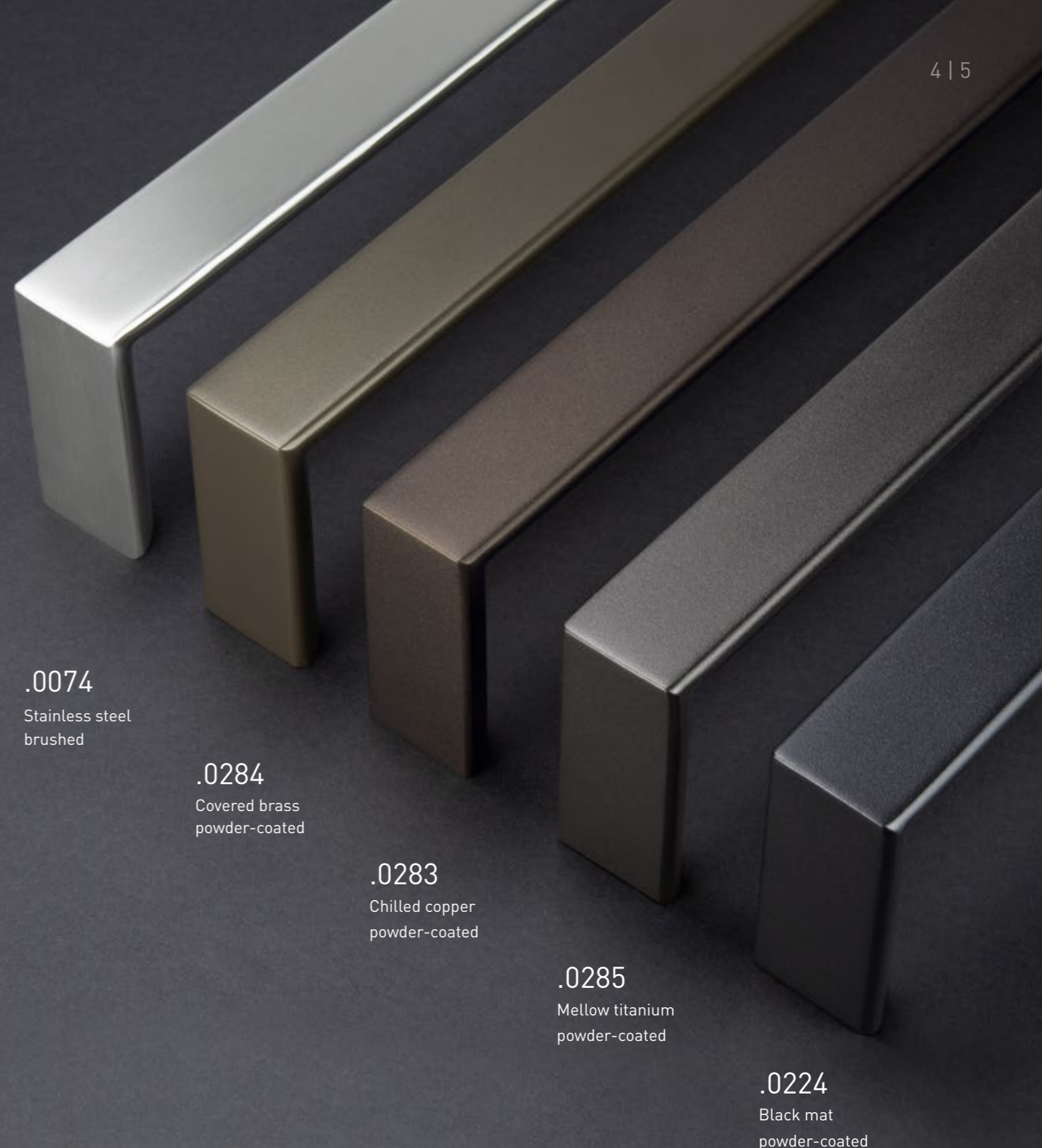

.0074
Stainless steel
brushed

.0284
Covered brass
powder-coated

.0283
Chilled copper
powder-coated

.0285
Mellow titanium
powder-coated

.0224
Black mat
powder-coated

COLOURS

Example for handle: 12342 → page 33



FRONT DOOR HANDLES STANDARD



Stainless steel tube handle Ø 32/25 mm, 90°

Art.No.	CC	L
12312	200	330
	200	400
	400	600
	600	800
	800	1000
	1000	1200
	1200	1400
	1400	1600
	1600	1800
	1800	2000

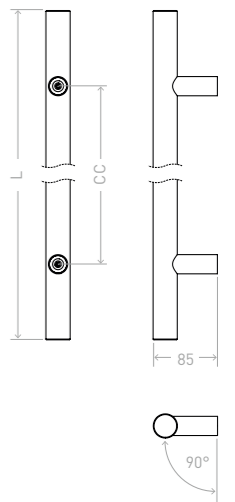

- *****.0074
- *****.0224

Universal fastening on page 58

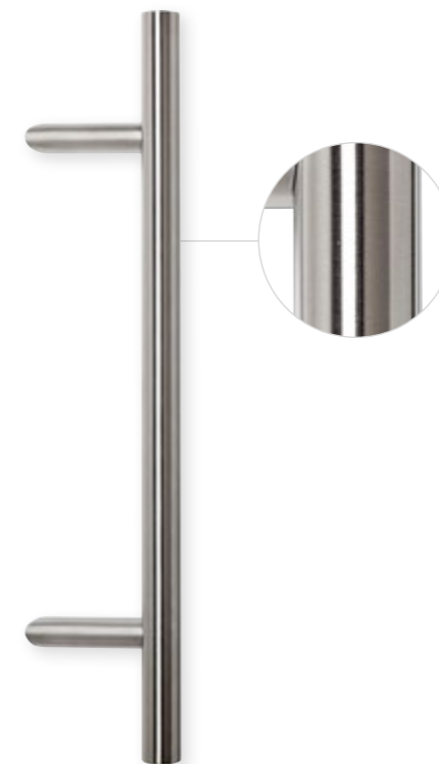

Stainless steel tube handle Ø 32/25 mm, 45°

Art.No.	CC	L
12160	200	330
	200	400
	400	600
	600	800
	800	1000
	1000	1200
	1200	1400
	1400	1600
	1600	1800
	1800	2000

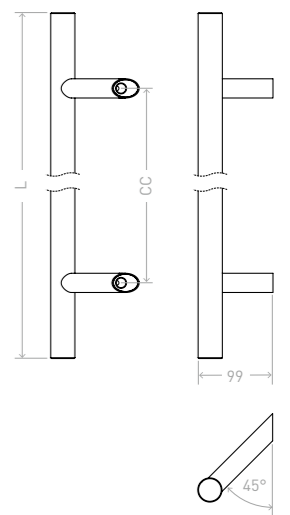

- *****.0074
- *****.0224

Universal fastening on page 58

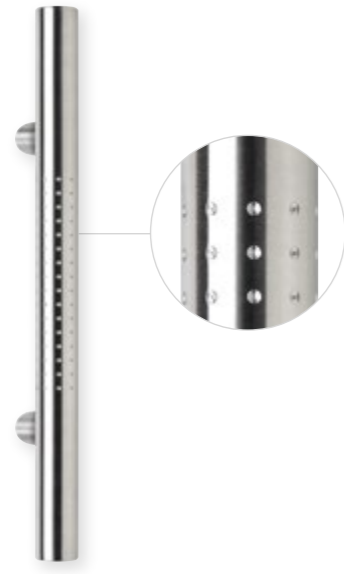

Stainless steel tube handle

Ø 32/25 mm, 90°, with dots

Art.No.	CC	L
12264	210	400
	400	600
	600	800
	800	1000
	1000	1200
	1200	1400
	1400	1600

Universal fastening on page 58

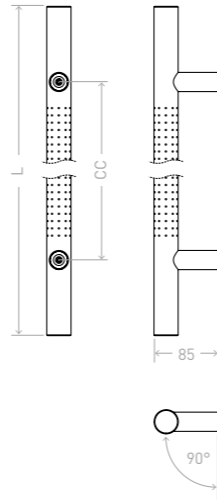

*****.0074

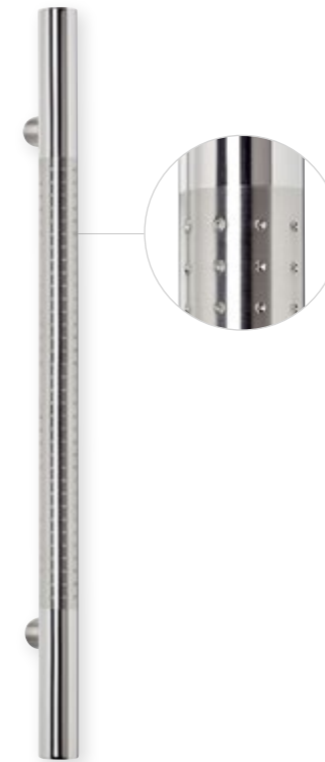

Stainless steel tube handle

Ø 32/25 mm, 90°, with dots, polished ends

Art.No.	CC	L
12263	210	400
	400	600
	600	800
	800	1000
	1000	1200
	1200	1400
	1400	1600

Universal fastening on page 58

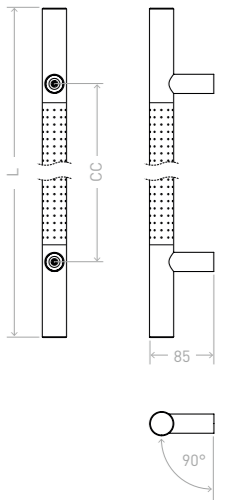

*****.0074



Stainless steel tube handle

Ø 32/25 mm, 45°, with dots

Art.No.	CC	L
12134	210	330
	210	400
	400	600
	600	800
	800	1000
	1000	1200
	1200	1400
	1400	1600

Universal fastening on page 58

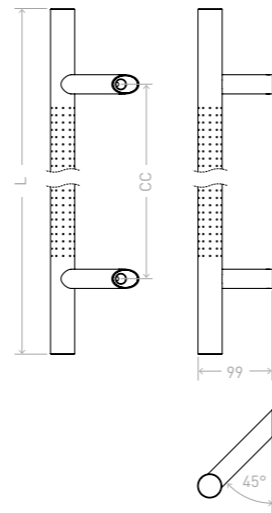

*****.0074



Stainless steel tube handle

Ø 32/25 mm, 45°, with dots, polished ends

Art.No.	CC	L
12161	210	330
	210	400
	400	600
	600	800
	800	1000
	1000	1200
	1200	1400
	1400	1600

Universal fastening on page 58

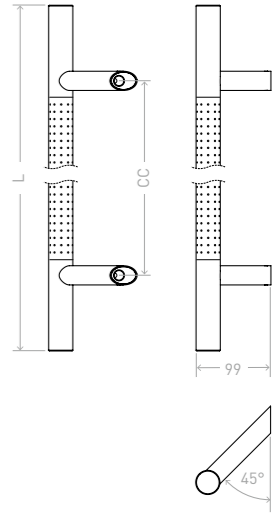

*****.0074



Stainless steel tube handle

Ø 32/25 mm, 90°, with polished grooves

Art.No.	CC	L
12321	210	400
	400	600
	600	800
	800	1000
	1000	1200
	1200	1400
	1400	1600

Universal fastening on page 58

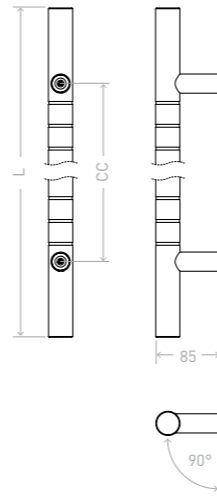

*****.0074



Stainless steel tube handle

Ø 32/25 mm, 90°, with polished grooves

Art.No.	CC	L
12322	210	400
	400	600
	600	800
	800	1000
	1000	1200
	1200	1400
	1400	1600

Universal fastening on page 58

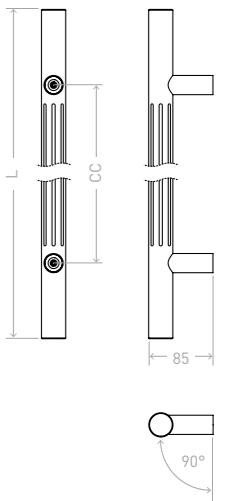

*****.0074



Stainless steel tube handle

Ø 32/25 mm, 45°, with polished grooves

Art.No.	CC	L
12209	210	330
	210	400
	400	600
	600	800
	800	1000

Universal fastening on page 58

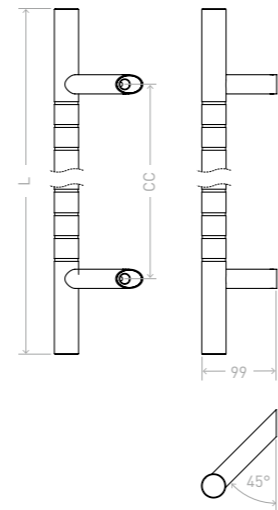

*****.0074



Stainless steel tube handle

Ø 32/25 mm, 45°, with polished grooves

Art.No.	CC	L
12208	210	330
	210	400
	400	600
	600	800
	800	1000

Universal fastening on page 58

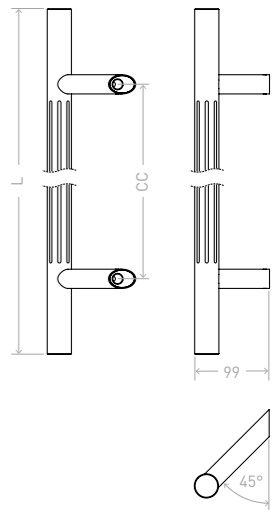

*****.0074



Stainless steel tube handle 65°

Art.No.	CC	L
12214	210	400
	400	600
	600	800
	800	1000

Universal fastening on page 58

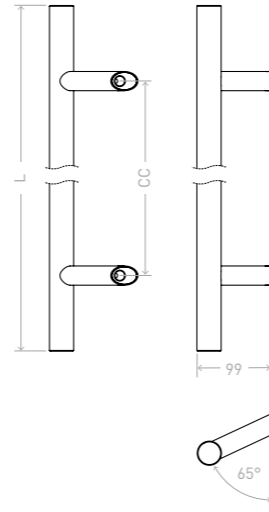

- *****.0074
- *****.0224



Stainless steel tube handle

Ø 25/25 mm, 45°

Art.No.	CC	L
12302	300	500

Universal fastening on page 58

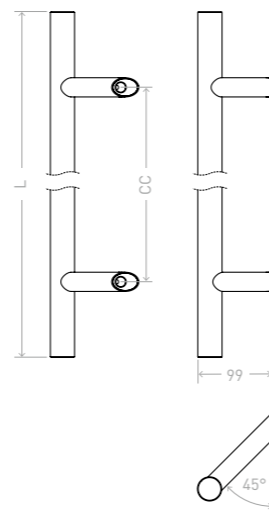

- *****.0074
- *****.0224



“Barrier-free” stainless steel tube handle

Ø 32/25 mm, brushed surface

Art.No.	CC	L
12248 <i>(DIN left door)</i>	1090	1260
12249 <i>(DIN right door)</i>	1090	1260

Universal fastening on page 58

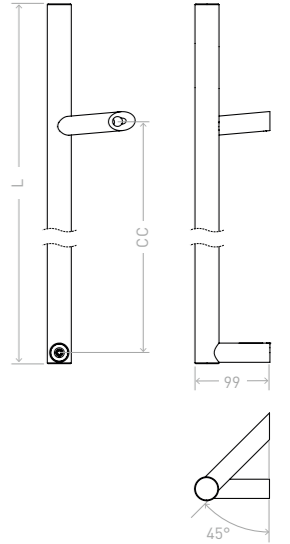

- *****.0074
- *****.0224





Stainless steel tube handle
33/27 mm, 90°

Art.No.	CC	L
12254	210	400
	400	600
	600	800
	800	1000
	1000	1200
	1200	1400
	1400	1600
	1600	1800
	1800	2000

Universal fastening on page 58

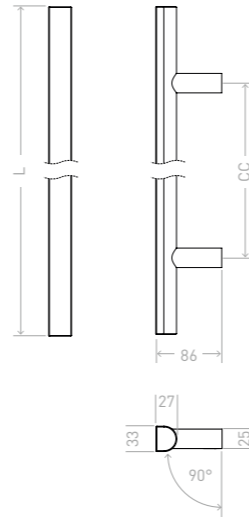

■ *****.0074
■ *****.0224



Stainless steel tube handle
33/27 mm, 90°, with dots, polished ends

Art.No.	CC	L
12258	210	400
	400	600
	600	800
	800	1000
	1000	1200
	1200	1400
	1400	1600

Universal fastening on page 58

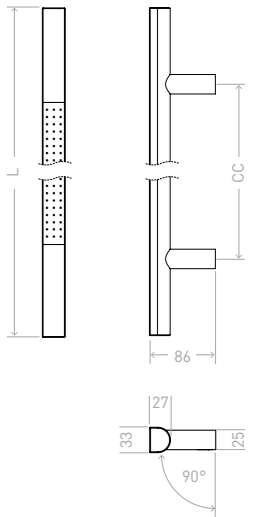

■ *****.0074

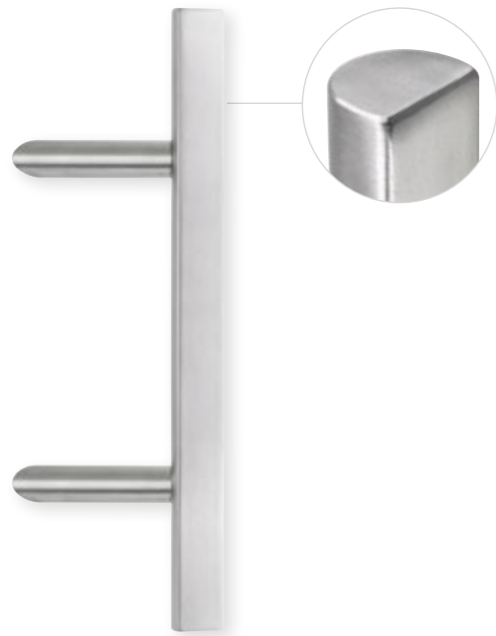

Stainless steel tube handle
33/27 mm, 45°

Art.No.	CC	L
12253	210	400
	400	600
	600	800
	800	1000
	1000	1200
	1200	1400
	1400	1600
	1600	1800
	1800	2000

Universal fastening on page 58

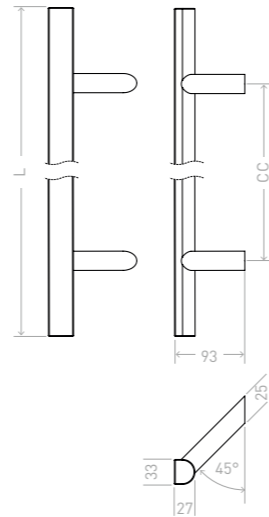

■ *****.0074
■ *****.0224



Stainless steel tube handle
33/27 mm, 45°, with dots, polished ends

Art.No.	CC	L
12259	210	400
	400	600
	600	800
	800	1000
	1000	1200
	1200	1400
	1400	1600

Universal fastening on page 58

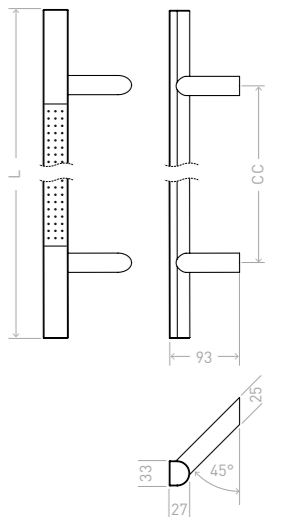

■ *****.0074



Stainless steel tube handle

Ø32 mm, 90°

Art.No.	CC	L
12125	350	382
	400	432
	600	632
	800	832

Universal fastening on page 58

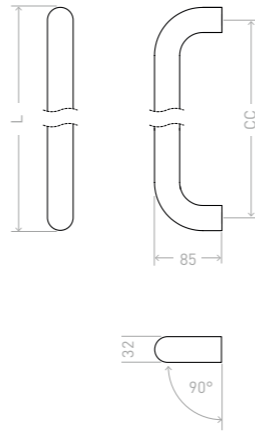

■ *****.0074
■ *****.0224



Stainless steel tube handle

Ø32 mm, 44°

Art.No.	CC	L
12137	500	588
	800	964

Universal fastening on page 58

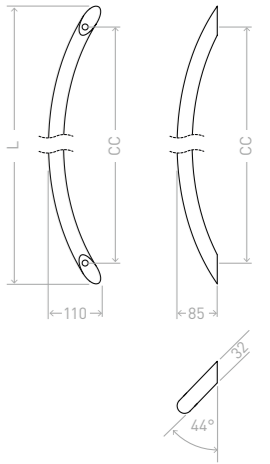

■ *****.0074
■ *****.0224



Stainless steel tube handle

Ø25 mm, 90°

Art.No.	CC	L
12049	300	325
	500	525

Universal fastening on page 58

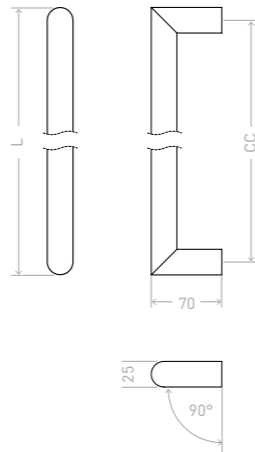

■ *****.0074
■ *****.0224



Stainless steel tube handle

Ø32 mm, 44°, with dots, polished ends

Art.No.	CC	L
12323	500	588
	800	964

Universal fastening on page 58

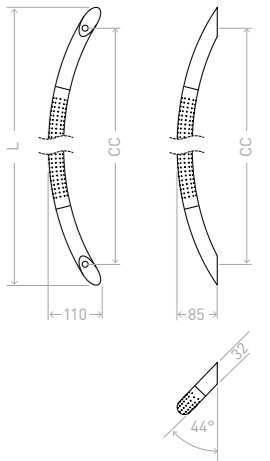

■ *****.0074



Stainless steel tube handle

Ø 32 mm, 44°, with polished grooves

Art.No.	CC	L
12324	500	588
	800	964

Universal fastening on page 58

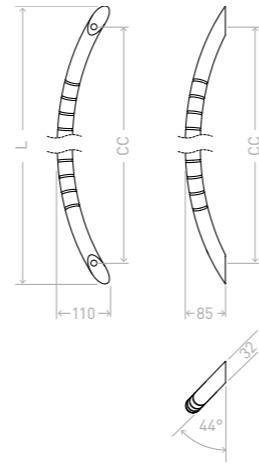

■ *****.0074



Stainless steel tube handle

Ø 32 mm

Art.No.	CC	L
12115	1435	1620

Universal fastening on page 58

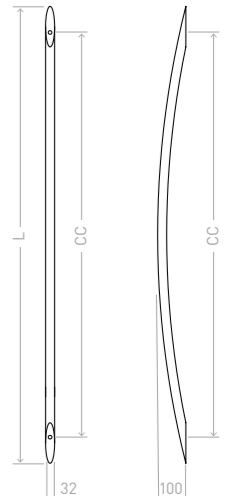

■ *****.0074

■ *****.0224

Stainless steel tube handle

Ø 32 mm, with dots, polished ends

Art.No.	CC	L
12184	1435	1620

Universal fastening on page 58

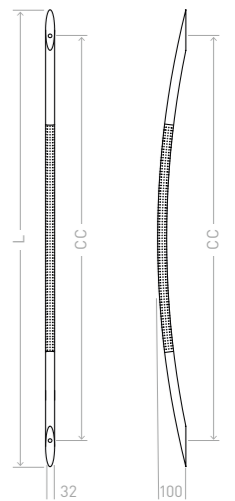

■ *****.0074



Stainless steel tube handle

Ø 32 mm

Art.No.	CC	L
12138	350	382
	800	832

Universal fastening on page 58

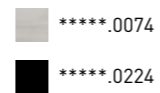
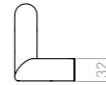
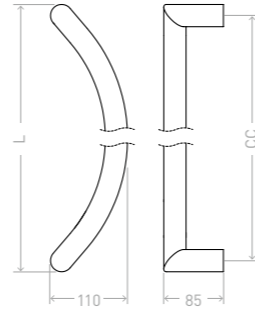

Stainless steel tube handle

Ø 32 mm

Art.No.	CC	L
12003	300	244
12013	350	274

Universal fastening on page 58

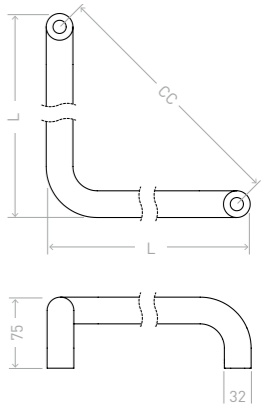

Stainless steel tube handle

Ø 32 mm

Art.No.	CC	L
12005	300	332
12018	350	382

Universal fastening on page 58

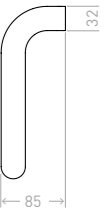
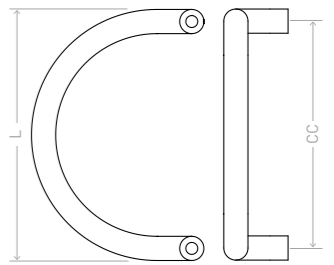

Stainless steel tube handle

Ø 32 mm, with dots, polished ends

Art.No.	CC	L
12325	350	382
	800	832

Universal fastening on page 58

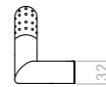
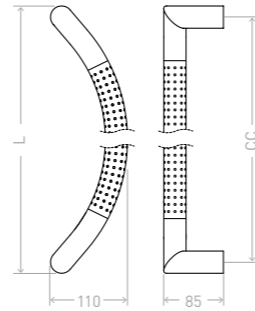

Stainless steel tube handle

Ø 32 mm

Art.No.	CC	L
12004	300	332
12017	350	382

Universal fastening on page 58

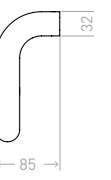
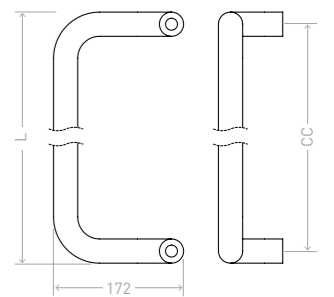



Stainless steel tube handle

Ø 32 mm

Art.No.	CC	L
12020	350	382

Universal fastening on page 58

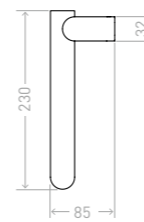
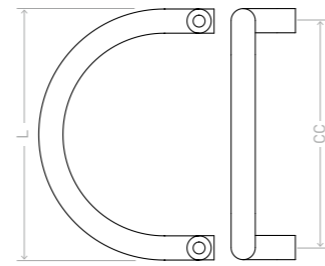

- *****.0074
- *****.0224



Stainless steel tube handle

Ø 32/25 mm

Art.No.	CC	L
12122	300	342

Universal fastening on page 58

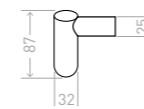
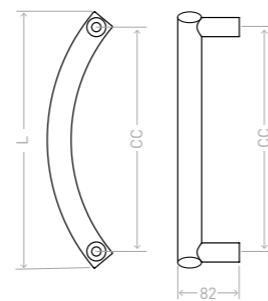

- *****.0074
- *****.0224





FRONT DOOR HANDLES CLASSIC DESIGN



Stainless steel handle

Art.No.	CC	L
12295	200	310

Universal fastening on page 58
or thread M8

■ *****.0074 ■ *****.0224

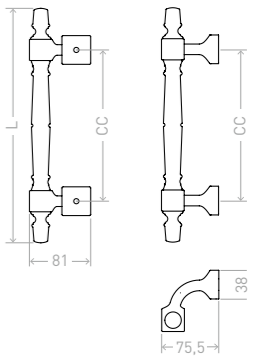

Stainless steel handle

Art.No.	CC	L
12296	230	320

Universal fastening on page 58
or thread M8

■ *****.0074 ■ *****.0224

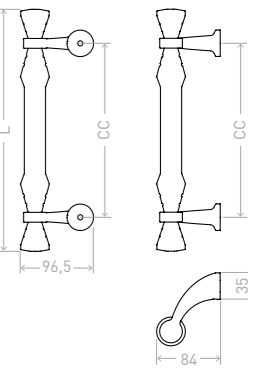

Stainless steel handle

Art.No.	CC	L
12297	230	325

Fastening 19346 (page 61)
or thread M8

■ *****.0074 ■ *****.0224

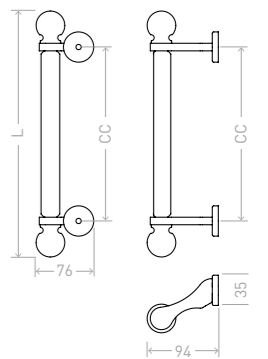



Stainless steel handle

Art.No.	CC	L
12316	230	326

Fastening 19346 or 19340 (page 61) or thread M8

■ *****.0071

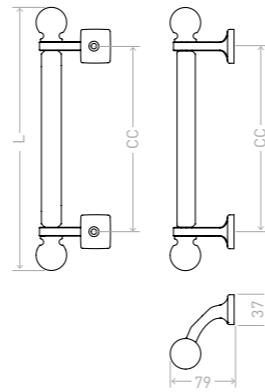

Stainless steel handle

Art.No.	CC	L
10061	210	290

Universal fastening on page 58

■ *****.0074 ■ *****.0224

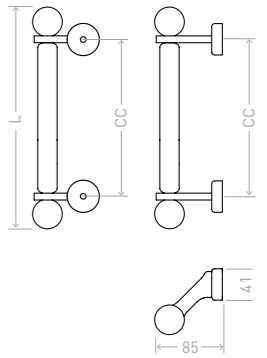

Stainless steel handle

Art.No.	CC	L
12317	210	253

Fastening 19346 or 19340 (page 61) or thread M8

■ *****.0071

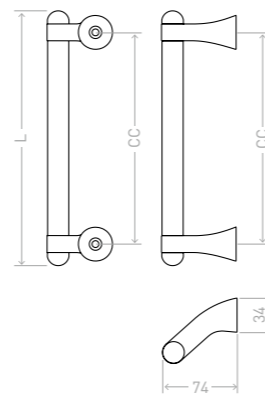

Stainless steel handle

Art.No.	CC	L
12318	201	291

Fastening 19346 or 19340 (page 61) or thread M8

■ *****.0032 ■ *****.0071

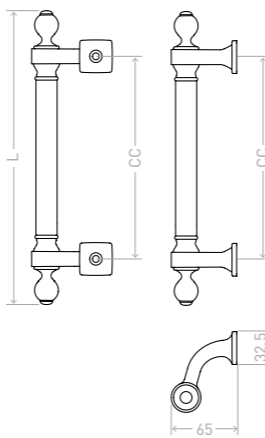



Stainless steel tube handle

Ø 25 mm

Art.No.	CC	L
12306	210	320

Universal fastening on page 58

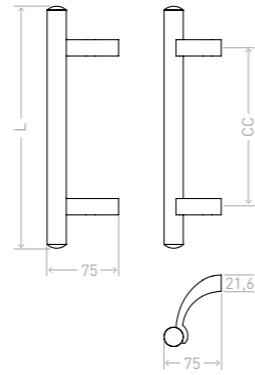

Stainless steel tube handle

Ø 27 mm

Art.No.	CC	L
12286	210	358

Universal fastening on page 58

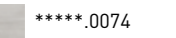
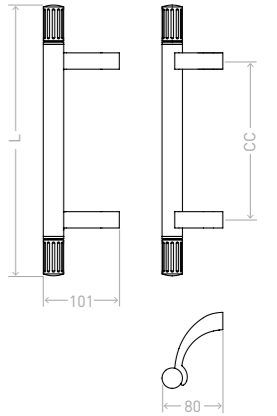

Stainless steel tube handle

Ø 25 mm

Art.No.	CC	L
12084	210	335

Universal fastening on page 58

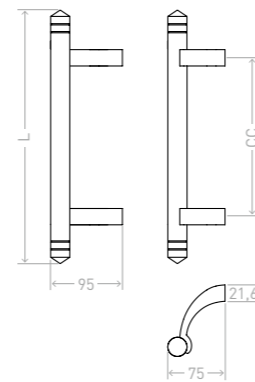

Stainless steel tube handle

Ø 32 mm, polished ends

Art.No.	CC	L
10082	210	350

Universal fastening on page 58

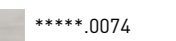
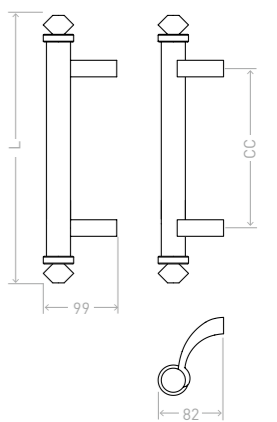



Stainless steel handle

Art.No.	CC	L
10120	210	398

Universal fastening on page 58

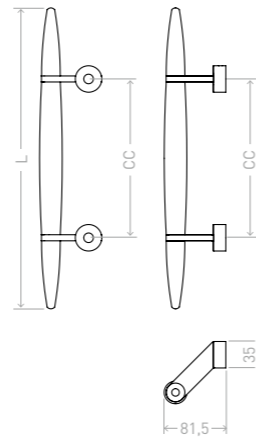

- *****.0074
- *****.0224



Stainless steel tube handle

Ø 30 mm

Art.No.	CC	L
12287	202	262

Universal fastening on page 58

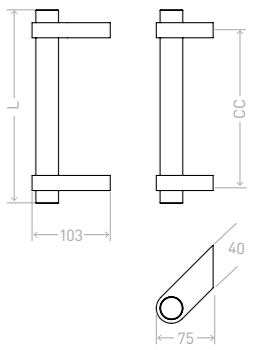

- *****.0074
- *****.0224



Stainless steel tube handle

Ø 32 mm, polished ends

Art.No.	CC	L
12279	430	620

Universal fastening on page 58

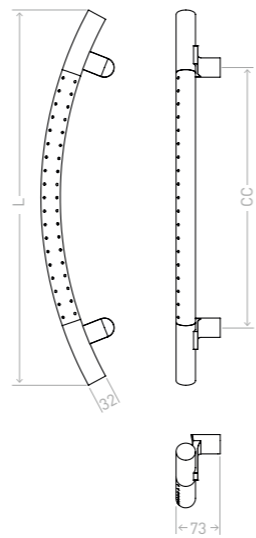

- *****.0074



Stainless steel tube handle

Ø 30 / 25 mm

Art.No.	CC	L
12273	200	310

Universal fastening on page 58

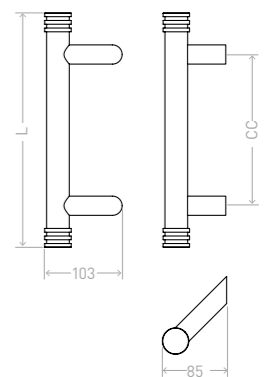

- *****.0074
- *****.0224



FRONT DOOR HANDLES MODERN DESIGN



Stainless steel tube handle

90°

Art.No.	W/D
12341	33/27
12342	40/20
12332	40/25
12245	45/25

Tube cross-section

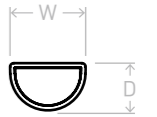

CC	L
380	400
580	600
780	800
980	1000
1180	1200
1380	1400
1580	1600
1780	1800
1980	2000

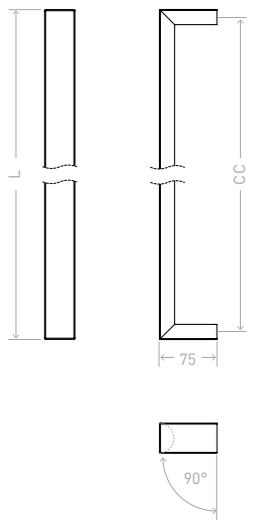

Universal fastening
on page 58

*****.0074

*****.0224

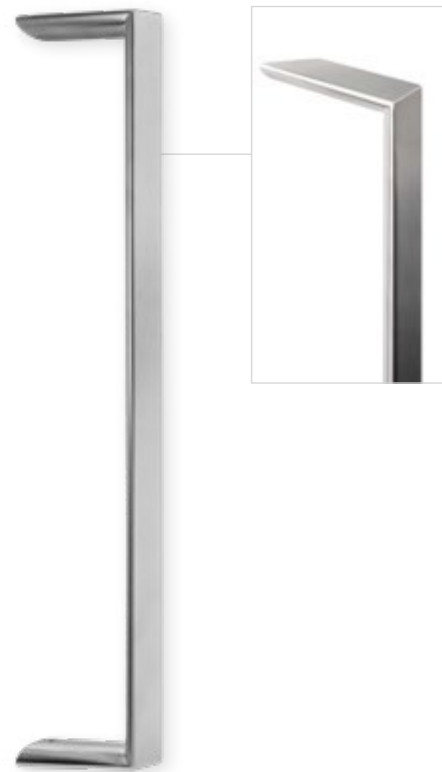

Stainless steel tube handle

45°

Art.No.	W/D
12290	40/20

Other cross-sectional dimensions on request

Tube cross-section

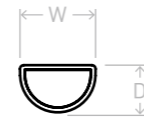

CC	L
380	400
580	600
780	800
980	1000
1180	1200
1380	1400
1580	1600
1780	1800
1980	2000

Universal fastening on page 58

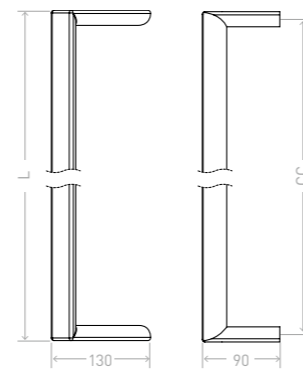

Stainless steel tube handle

45°

Art.No.	W/D
12315	40/20

Other cross-sectional dimensions on request

Tube cross-section

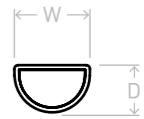

CC	L
380	400
580	600
780	800
980	1000
1180	1200
1380	1400
1580	1600
1780	1800
1980	2000

Universal fastening on page 58

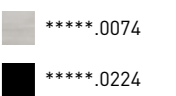
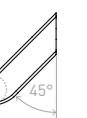
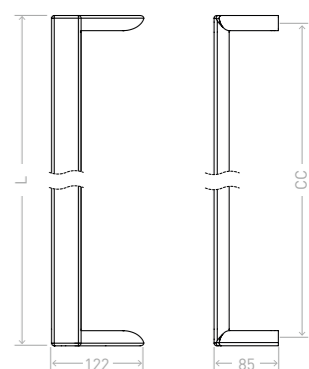



Aluminium handle

90°

Art.No.	W/D
12336	40/20
12343	40/25
12337	45/25

CC	L
380	400
580	600
780	800
980	1000
1180	1200
1380	1400
1580	1600

Universal fastening on page 58

Tube cross-section

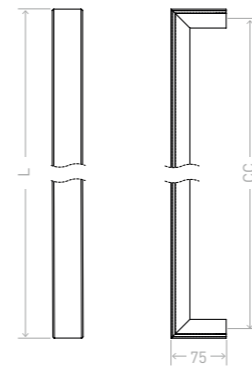
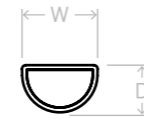

- *****.0000
- *****.0224

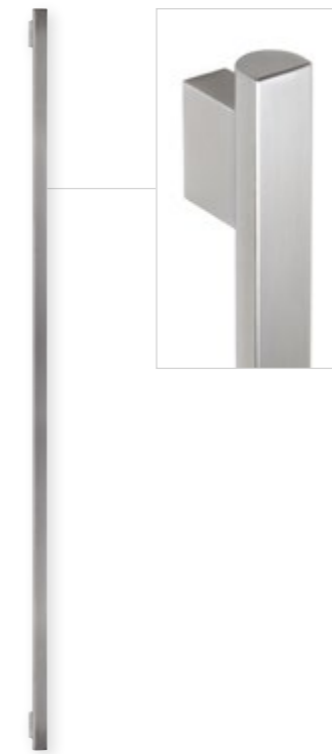

Stainless steel tube handle

33/27 mm, 90°

Art.No.	CC	L
12311	291	400
	491	600
	691	800
	891	1000
	1091	1200
	1291	1400
	1491	1600
	1691	1800
	1891	2000

Universal fastening on page 58

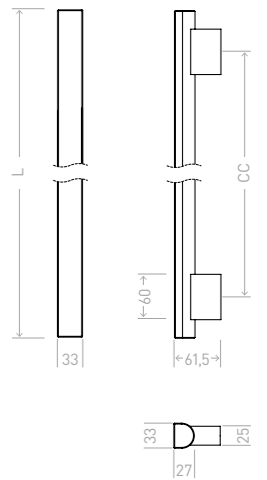

- *****.0074
- *****.0224



Stainless steel tube handle

Ø 34 mm, 90°

Art.No.	CC	L
12278	291	400
	491	600
	691	800
	891	1000
	1091	1200
	1291	1400
	1491	1600
	1691	1800
	1891	2000

Universal fastening on page 58

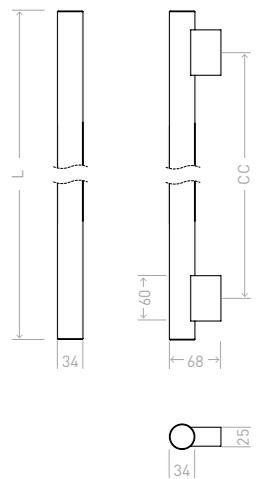

- *****.0074
- *****.0224



Stainless steel tube handle

30 x 30 mm, 90°

Art.No.	CC	L
12327	210	400
	400	600
	600	800
	800	1000
	1000	1200
	1200	1400
	1400	1600
	1600	1800
	1800	2000

Universal fastening on page 58

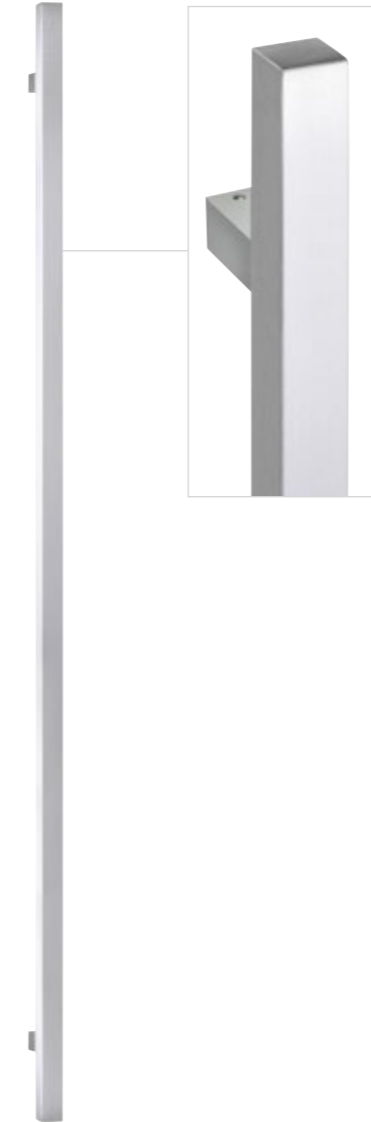
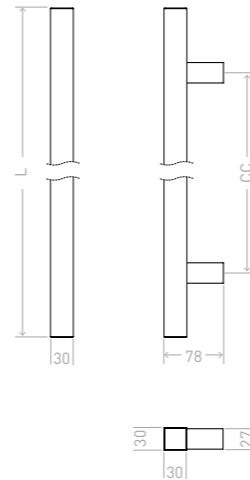

Aluminium handle

30 x 30 mm, 90°

Art.No.	CC	L
12271	210	400
	400	600
	600	800
	800	1000
	1000	1200
	1200	1400
	1400	1600

Universal fastening on page 58

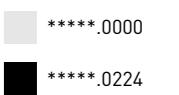
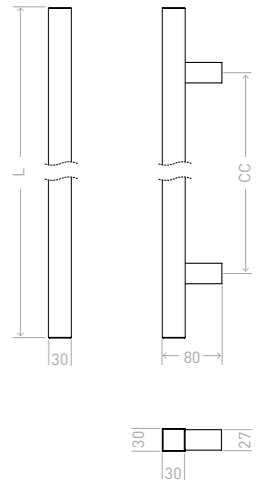

Stainless steel tube handle

30 x 30 mm, 90°, polished ends

Art.No.	CC	L
12328	210	400
	400	600
	600	800
	800	1000
	1000	1200
	1200	1400
	1400	1600

Universal fastening on page 58

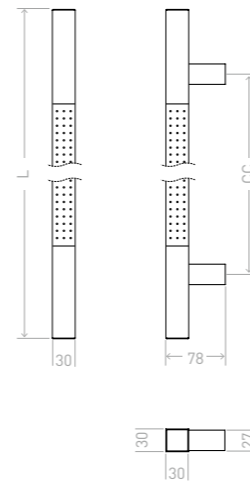



Stainless steel tube handle

32 x 32 mm, 45°

Art.No.	CC	L
12192	300	500

Universal fastening on page 58

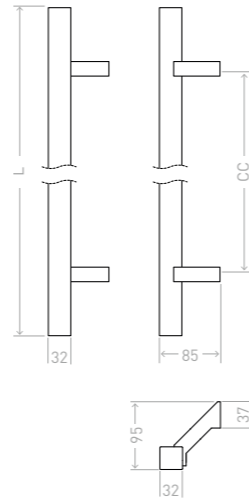

- *****.0074
- *****.0224



Stainless steel handle

40 x 10 mm

Art.No.	CC	L
12256	200	400
	400	600
	600	800
	800	1000
	1000	1200
	1200	1400

Universal fastening on page 58

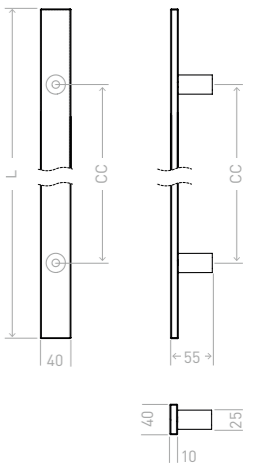

- *****.0074
- *****.0224



Stainless steel tube handle

40/20 mm, 45°

Art.No.	CC	L
12185	350	370

Universal fastening on page 58

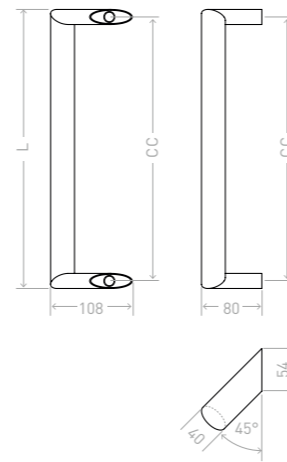

- *****.0074
- *****.0224

Stainless steel handle

40 x 10 mm

Art.No.	CC	L
12272	600/600	1600
	700/700	1800

Universal fastening on page 58

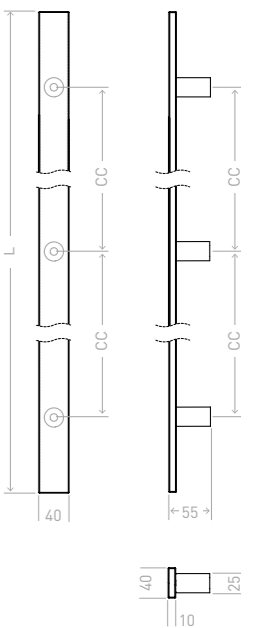

- *****.0074
- *****.0224



Stainless steel handle

40 x 10 mm

Art.No.	CC	L
12255	840	1000

Universal fastening on page 58

■ *****.0074 ■ *****.0224

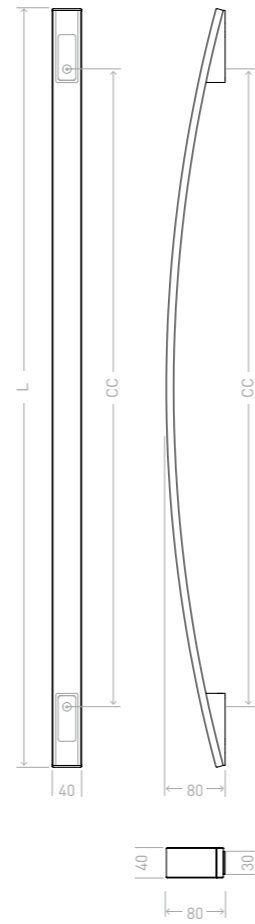

Stainless steel tube handle

Ø 25 mm

Art.No.	CC	L
12130	800	836

Universal fastening on page 58

■ *****.0074 ■ *****.0224

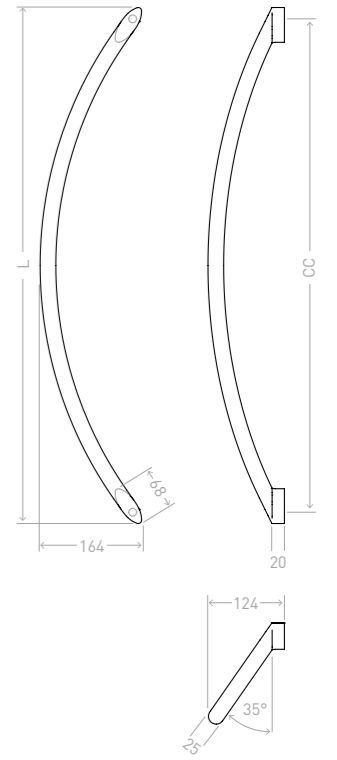

Stainless steel tube handle

Ø 25 mm

Art.No.	CC	L
12149	500	530

Universal fastening on page 58

■ *****.0074 ■ *****.0224

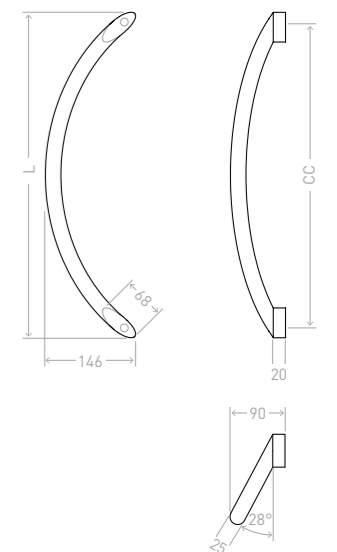



Stainless steel tube handle

Ø 32 mm

Art.No.	CC	L
12133	350	550

Front attachment

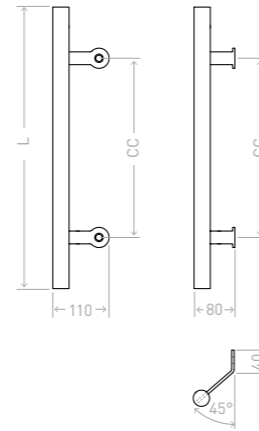

- *****.0074
- *****.0224



Tube handle made of stainless steel and carbon

Ø 32/25 mm, 45°, polished ends

Art.No.	CC	L
12242	600	1000

Universal fastening on page 58

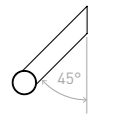
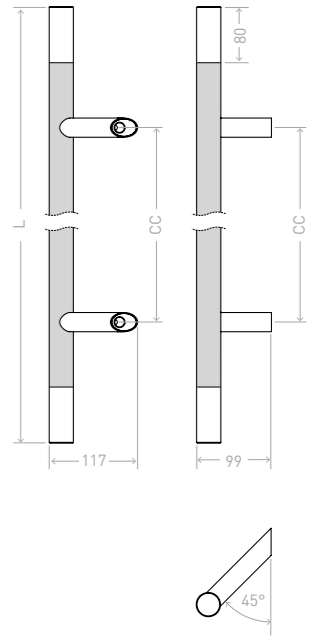

- *****.7457

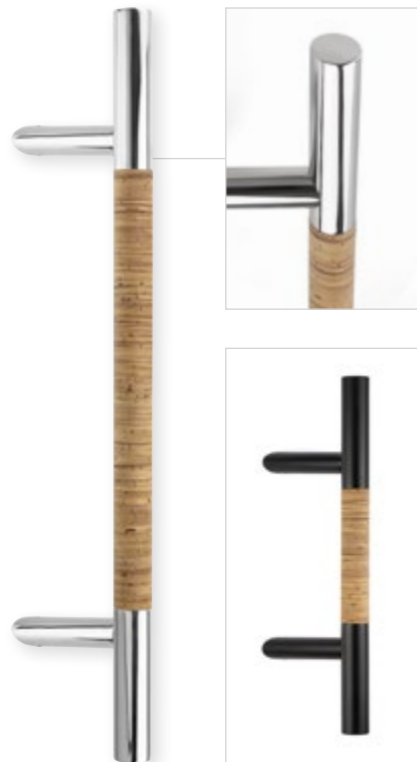

Stainless steel tube handle and real birch wood

Ø 32/25 mm, 45°, polished ends

Art.No.	CC	L
12262	210	400
	400	600
	600	800

Universal fastening on page 58

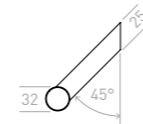
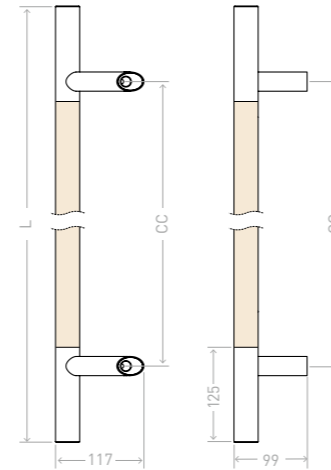

- *****.0074
- *****.0224

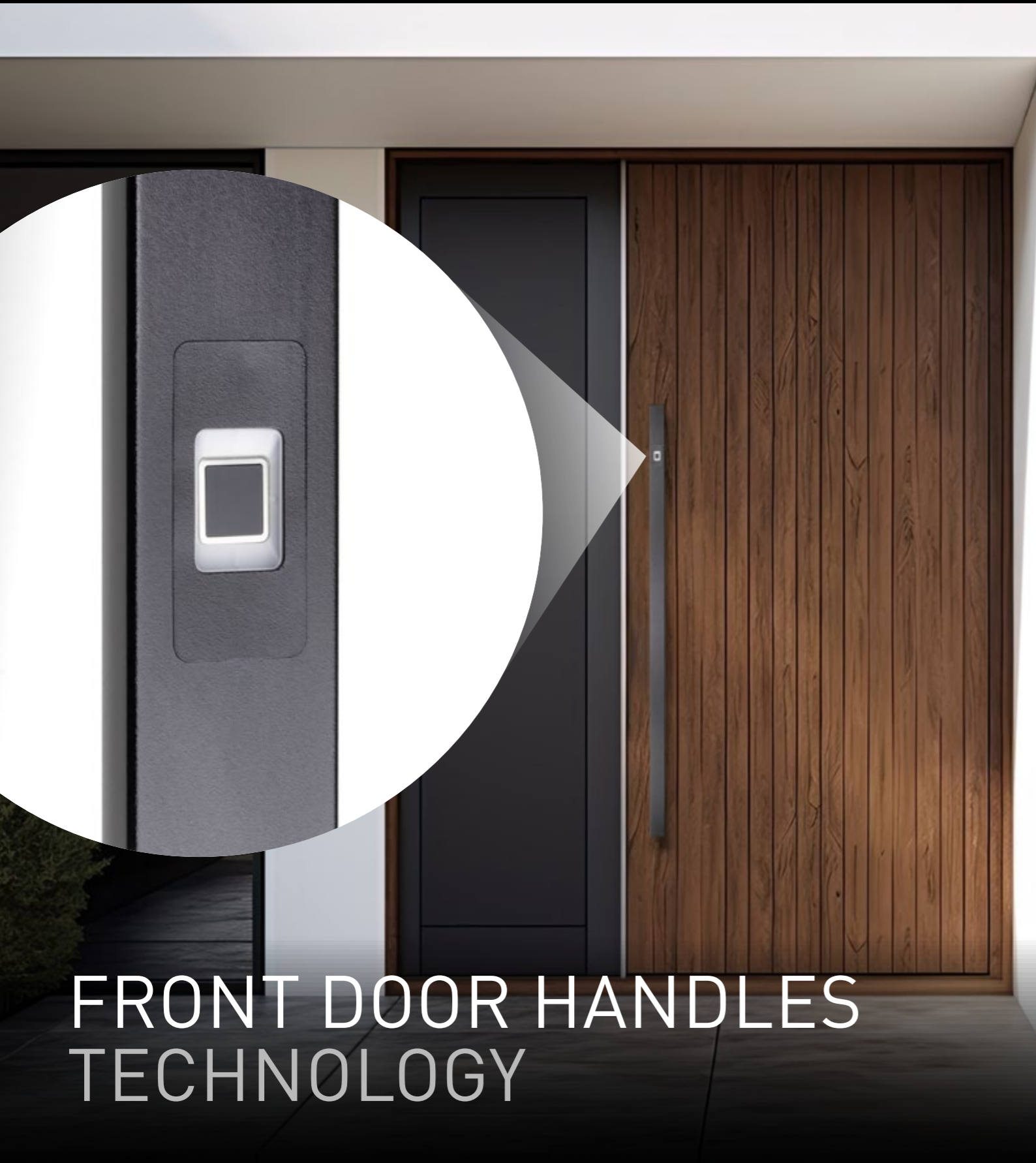

FRONT DOOR HANDLES TECHNOLOGY

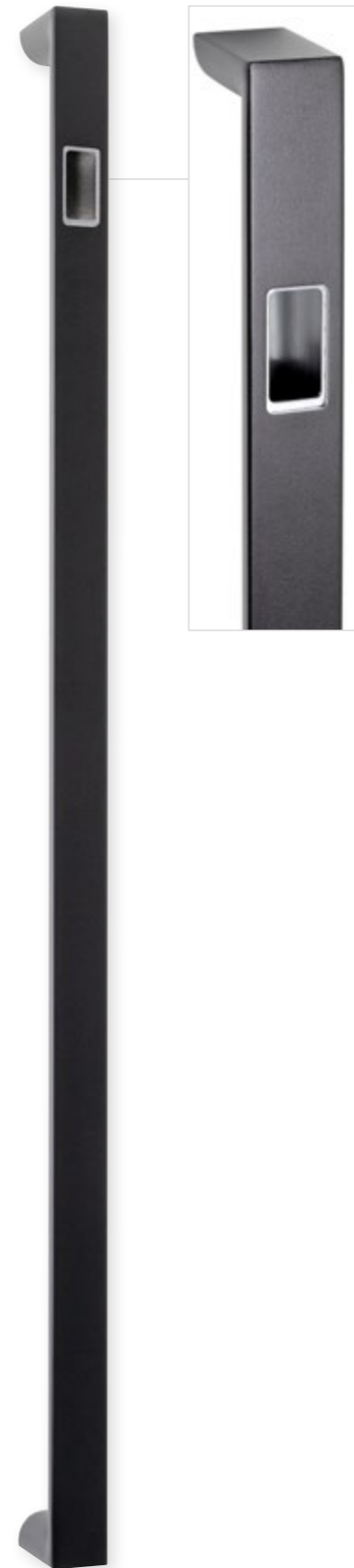

Stainless steel tube handle prepared for finger scan

90°

Art.No.	W/D	Scanner
12334	33/27	ekey dLine
12333	40/25	ekey dLine
12335	45/25	ekey dLine IDENCOM Navkom

CC	L	A
380	400	variable
580	600	variable
780	800	variable
980	1000	variable
1180	1200	variable
1380	1400	variable
1580	1600	variable
1780	1800	variable
1980	2000	variable

Individual attachment
and cable routing

Tube cross-section

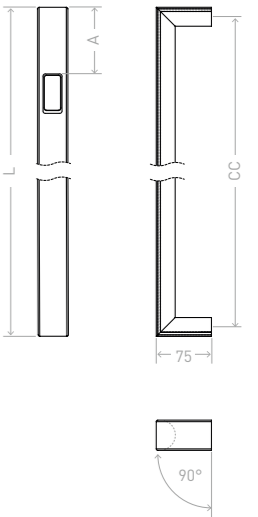
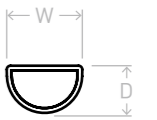

*****.0074

*****.0224

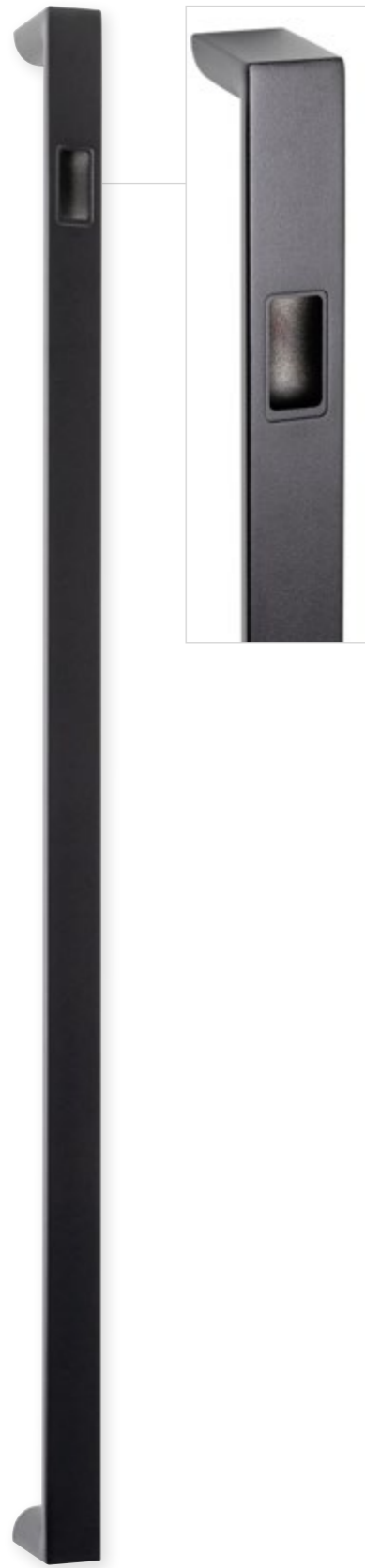

**Aluminium handle
prepared fo finger scan ekey dLine**
90°

Art.No.	W/D
12344	40/25
12338	45/25

CC	L	A
380	400	variable
580	600	variable
780	800	variable
980	1000	variable
1180	1200	variable
1380	1400	variable
1580	1600	variable

Individual attachment
and cable routing

Tube cross-section

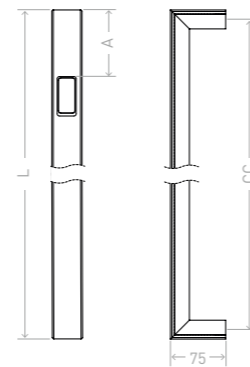
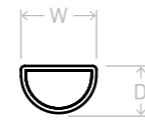

- *****.0000
- *****.0224



**Stainless steel tube handle
prepared fo finger scan ekey dLine**
33/27 mm, 90°

Art.No.	CC	L	A
12330	210	400	variable
	400	600	variable
	600	800	variable
	800	1000	variable
	1000	1200	variable
	1200	1400	variable
	1400	1600	variable
	1600	1800	variable
	1800	2000	variable

Individual attachment and cable routingl

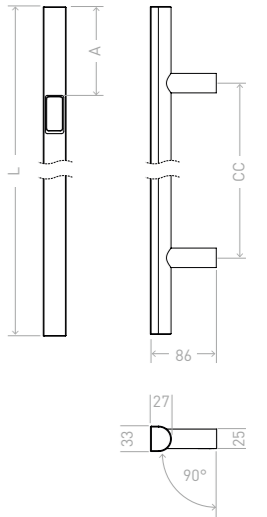

- *****.0074
- *****.0224



**Stainless steel tube handle
prepared fo finger scan ekey dLinee**
33/27 mm, 45°

Art.No.	CC	L	A
12329	210	400	variable
	400	600	variable
	600	800	variable
	800	1000	variable
	1000	1200	variable
	1200	1400	variable
	1400	1600	variable
	1600	1800	variable
	1800	2000	variable

Individual attachment and cable routing

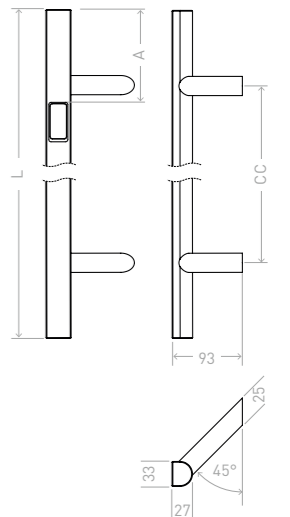

- *****.0074
- *****.0224



FRONT DOOR HANDLES RENOVATION



Stainless steel tube handle

Ø 25/32 mm, 45°, brushed surface
Variable length / drilling distance

Art.No.	CC	L
12023	variable	variable

Universal fastening on page 58

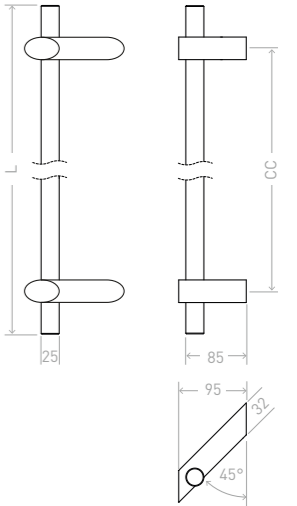

- *****.0074
- *****.0224



Stainless steel tube handle

Ø 32/25 mm, 50°, brushed surface
Variable length / drilling distance

Art.No.	CC	L
12227	variable	variable

Universal fastening on page 58

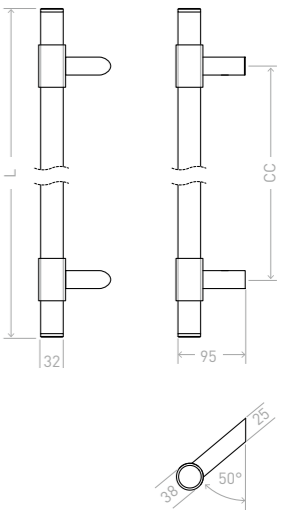

- *****.0074
- *****.0224



Stainless steel tube handle

Ø 25/32 mm, 90°, brushed surface
Variable length / drilling distance

Art.No.	CC	L
12308	variable	variable
	H1	H2
min.	70	38
max.	135	103

Universal fastening on page 58

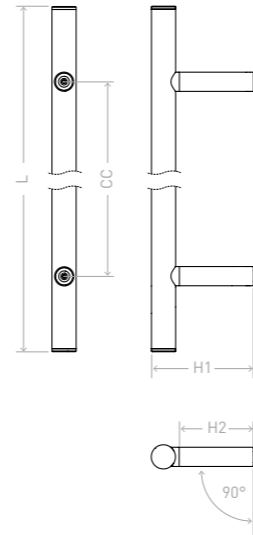

■ *****.0074
■ *****.0224



Stainless steel tube handle

Ø 25/32 mm, 90°, brushed surface
Variable length / drilling distance

Art.No.	CC	L
12310	variable	variable
	H1	H2
min.	70	38
max.	135	103

Universal fastening on page 58

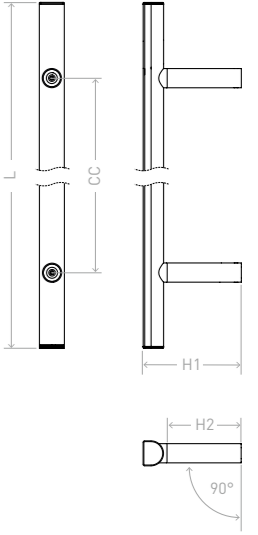

Preparation for
finger scan *ekey dLine*
possible

■ *****.0074
■ *****.0224



Stainless steel tube handle

Ø 25/32 mm, 90°, brushed surface
Variable length / drilling distance

Art.No.	CC	L
12307	variable	variable
	H1	H2
min.	58	52
max.	134	160

Universal fastening on page 58

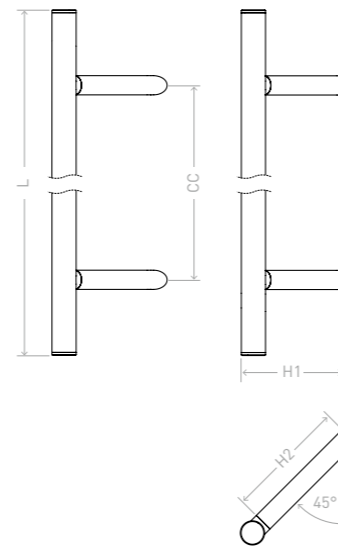

■ *****.0074
■ *****.0224



Stainless steel tube handle

Ø 25/32 mm, 90°, brushed surface
Variable length / drilling distance

Art.No.	CC	L
12309	variable	variable
	H1	H2
min.	53	52
max.	129	160

Universal fastening on page 58

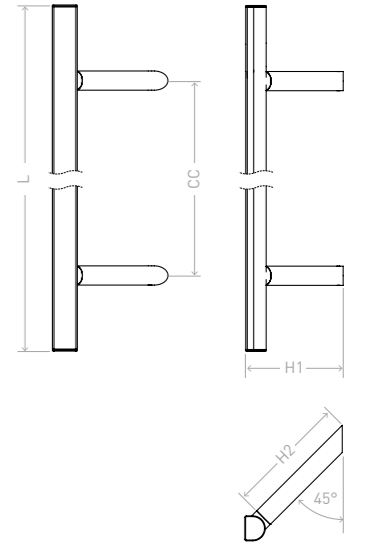

Preparation for
finger scan *ekey dLine*
possible

■ *****.0074
■ *****.0224



Aluminium handle

40/25 mm, 90°

Variable length / drilling distance

Art.No.	CC	L
12319	variable	variable

Universal fastening on page 58

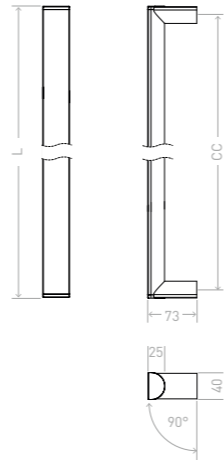

Preparation for finger scan ekey dLine possible

- *****.0000
- *****.0224



Stainless steel tube handle

33/27 mm, 90°

Variable length / drilling distance

Art.No.	CC	L
12326	variable	variable

Universal fastening on page 58

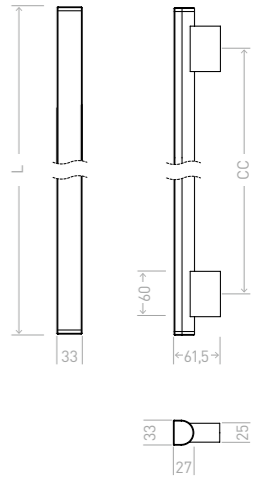

Preparation for finger scan ekey dLine possible

- *****.0074
- *****.0224



FASTENING

The confurn universal fastening

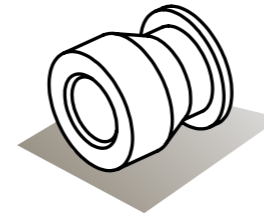

The majority of our handles can be securely and conveniently mounted with the universal fastening. The combination of fixing head and threaded accessories depends on the type of fixing and the nature of the door. The following examples show four installation options. Handles with special fixing screws are labelled accordingly.

We are gladly prepared to advise you correspondingly.

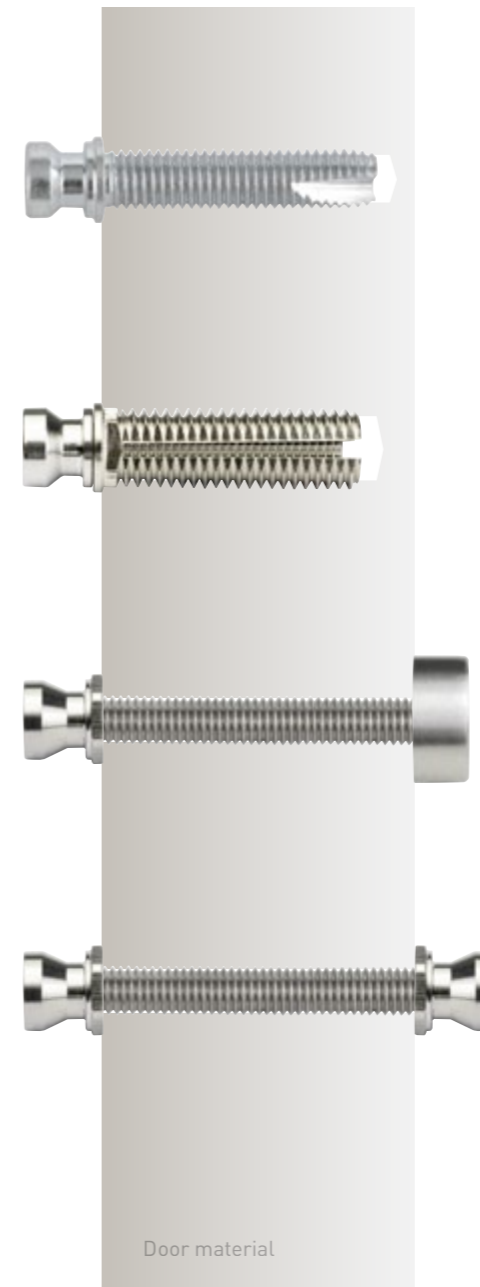

- 1 **One-sided fastening**
with self-tapping screw
- 2 **One-sided fastening**
with M8 screw and expansion dowel
- 3 **One-sided protruding fastening**
with threaded socket, threaded rod
and covering nut
- 4 **Double-sided fastening**
with two threaded sockets
and threaded rod

Door material

Universal fastening

Screw ST Ø 8 mm / SW6



Art.No.	Length of thread	Ø Drill bit	Material
19011	20 mm	8 mm	Stainless steel
19005	30 mm	8 mm	Stainless steel
19022	34 mm	8 mm	Stainless steel
19052	40 mm	8 mm	Stainless steel
19017	45 mm	8 mm	Stainless steel
19055	48 mm	8 mm	Galvanised steel

M10 self-tapping screw / SW6

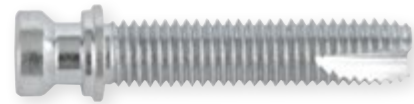

Art.No.	Length of thread	Ø Drill bit	Material
19327	20 mm	8.5 mm	Galvanised steel
19328	30 mm	8.5 mm	Galvanised steel
19329	45 mm	8.5 mm	Galvanised steel
19330	60 mm	8.5 mm	Galvanised steel

Screw M8 / SW6



Art.No.	Length of thread	Ø Drill bit	Material
19015	8 mm	6.8 mm	Stainless steel
19020	11,5 mm	6.8 mm	Stainless steel
19047	14 mm	6.8 mm	Stainless steel
19039	20 mm	6.8 mm	Stainless steel
19014	40 mm	6.8 mm	Stainless steel

Threaded socket with M8 internal thread



Art.No.	Material
19004	Stainless steel
19070	with screw locking Stainless steel

Accessories for M8 threaded socket

M8 adapter screw ST Ø 6.7 mm



Art.No.	Length of thread	Ø Drill bit	Material
19032	30 mm	6.7 mm	Steel
19081	50 mm	6.7 mm	Steel

M8 threaded rods for threaded socket



Art.No.	Length of thread	Ø Drill bit	Material
19089	25 mm	8 mm	Stainless steel
19074	65 mm	8 mm	Stainless steel
19068	75 mm	8 mm	Stainless steel
19095	100 mm	8 mm	Stainless steel
19006	120 mm	8 mm	Galvanised steel

Expansion dowel for M8 screws



Art.No.	Length of thread	Ø Drill bit	Material
19003	41.5 mm	12 mm	Brass

M8 nuts



Art.No.	Material
19002	Cap nut Stainless steel
11007	Covering nut Ø 25 mm Stainless steel



Accessories for universal fastening

Washer round for 90° base



Art.No.		Size	Thickness	Material
19096		Ø 24 mm	1 mm	PVC transparent
19336	with clamping edge	Ø 25.8 mm	0.7 mm	Plastic
19058	for glass door	Ø 24 mm	1 mm	PVC transparent

Washer oval for 45° base



Art.No.		Size	Thickness	Material
19097		25 x 35 mm	1 mm	PVC transparent
19335	with clamping edge	26 x 37 mm	0.7 mm	Plastic
19064	for glass door	25 x 35 mm	1.4 mm	PVC transparent

Washer oval for handle 12137



Art.No.		Size	Thickness	Material
19065		29 x 35 mm	1 mm	PVC transparent

Plastic sleeve for glass doors



Art.No.		Size	Thickness	Material
19048		Ø 12 mm	10 mm	PVC

Cover plate for renovation



Art.No.		Size	Thickness	Material
19046		Ø 85 mm	2 mm	Stainless steel

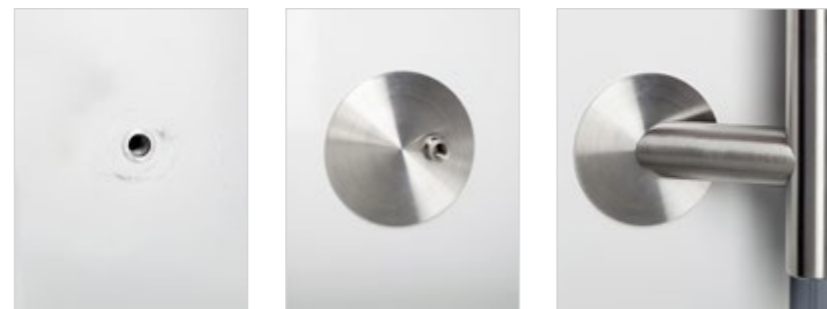

“Classic” fastening

for handles 12316, 12317 and 12318 (page 26)

Screw M8



Art.No.	Length of thread	Ø Drill bit	Material
19340	15 mm	8 mm	Steel

Screw ST

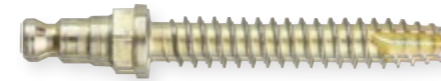

Art.No.	Length of thread/ Ø	Ø Drill bit	Material
19028	34 mm / 10 mm	8 mm	Steel
19056	48 mm / 10 mm	8 mm	Steel
19346	50 mm / 8 mm	6 mm	Steel

Special screw

for handle 12260 (page 37)

Screw M8



Art.No.	Length of thread	Ø Drill bit	Material
19334	22 mm	6.8 mm	Steel



ESCUTCHEONS



Escutcheon made of stainless steel

Art.No.	Ø	Drill size	Depth
11005	24.7	21.2	6.9

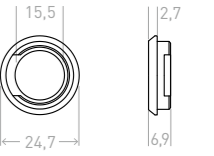

- *****.0074
- *****.0224



Escutcheon made of stainless steel

Art.No.	Ø	Drill size	Depth
11033	28	21.2	8.9

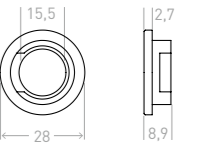

- *****.0074
- *****.0224



Escutcheon made of stainless steel

Art.No.	Ø	Drill size	Depth
11010	32	21.2	8.9

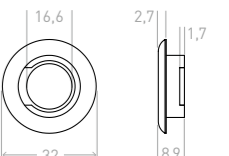

- *****.0074
- *****.0224



Escutcheon made of stainless steel

Art.No.	Ø	Drill size	Depth
11013	32	21.2	8.9

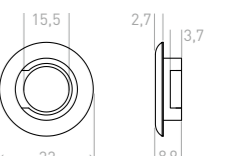

- *****.0074
- *****.0224



Escutcheon made of stainless steel

Art.No.	Ø	Drill size	Depth
11039	26	20	6

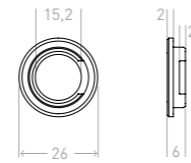

- *****.0074
- *****.0224



Design escutcheon made of stainless steel

Art.No.	Size	Depth
11004	33 x 74	9

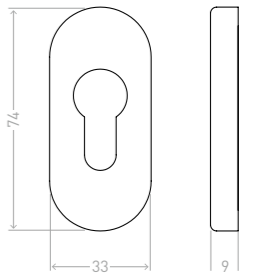

- *****.0074
- *****.0224



Escutcheon made of stainless steel

Art.No.	Ø	Drill size	Depth
11040	26	20	13

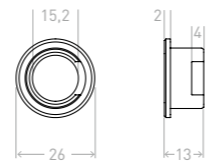

- *****.0074
- *****.0224



Design escutcheon made of stainless steel

Art.No.	Size	Depth
11001	29 x 67	9.5

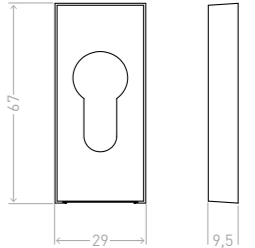

- *****.0074
- *****.0224



Escutcheon made of aluminium

Art.No.	Ø	Drill size	Depth
11037	26	20	6

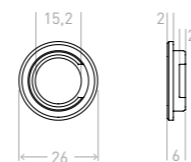

- *****.0000
- *****.0224



Design escutcheon made of stainless steel with pull protection and anti-drilling protection

Art.No.	Size	Depth
11003	33 x 74	15.5

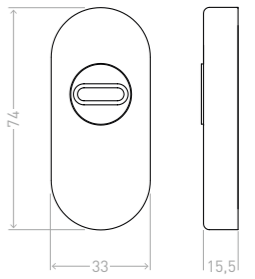

- *****.0074
- *****.0224



Escutcheon made of aluminium

Art.No.	Ø	Drill size	Depth
11038	26	20	13

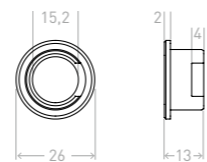

- *****.0000
- *****.0224



Design escutcheon made of stainless steel with pull protection, anti-drilling protection and height adjustment

Art.No.	Size	Depth
11011	37 x 74	14 - 21.5

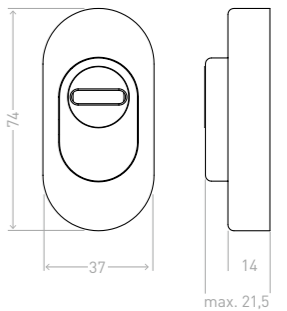

- *****.0074
- *****.0224



HOUSE NUMBERS ACCESSORIES



House numbers made of stainless steel

Art.No.	Figure	Size	⊕⊖
60000	0	120 x 150	130
60001	1	75 x 150	130
60002	2	104 x 150	130
60003	3	110 x 150	130
60004	4	119 x 150	130
60005	5	114 x 150	130
60006	6	112 x 150	130
60007	7	107 x 150	130
60008	8	116 x 150	130
60009	9	112 x 150	130
60010	a	104 x 117	95
60011	b	105 x 147	95
60012	c	103 x 115	95
60013	d	105 x 147	95



Maintenance kit for stainless steel

Art.No.
71000

Art.No.	Page	Art.No.	Page	Art.No.	Page	Art.No.	Page
10061	27	12137	17	12290	34	12337	36
10082	29	12138	20	12295	25	12338	48
10120	30	12149	43	12296	25	12341	33
11001	65	12160	7	12297	25	12342	33
11003	65	12161	9	12302	12	12343	36
11004	65	12184	19	12306	28	12344	48
11005	63	12185	40	12307	52	19002	59
11007	59	12192	40	12308	52	19003	59
11010	63	12208	11	12309	53	19004	58
11011	65	12209	10	12310	53	19005	58
11013	63	12214	12	12311	37	19006	59
11033	63	12227	51	12312	7	19011	58
11037	64	12242	45	12315	35	19014	58
11038	64	12245	33	12316	26	19015	58
11039	64	12248	13	12317	26	19017	58
11040	64	12249	13	12318	26	19020	58
12003	21	12253	14	12319	54	19022	58
12004	21	12254	14	12321	10	19028	61
12005	21	12255	42	12322	11	19032	59
12013	21	12256	41	12323	17	19039	58
12017	21	12258	15	12324	18	19046	60
12018	21	12259	15	12325	20	19047	58
12020	22	12262	44	12326	55	19048	60
12023	51	12263	9	12327	38	19052	58
12049	16	12264	8	12328	38	19055	58
12084	28	12271	39	12329	49	19056	61
12115	19	12272	41	12330	49	19058	60
12122	22	12273	31	12332	33	19064	60
12125	16	12278	37	12333	47	19065	60
12130	43	12279	30	12334	47	19068	59
12133	44	12286	29	12335	47	19070	58
12134	8	12287	31	12336	36	19074	59

SURFACES

- *****.0000 Aluminium raw brushed
- *****.0032 Shiny gold PVD
- *****.0071 Shiny chrome
- *****.0074 Stainless steel brushed
- *****.7457 Stainless steel brushed/carbon
- *****.0224 Black matt powder-coated
- *****.0283 Chilled copper powder-coated
- *****.0284 Covered brass powder-coated
- *****.0285 Mellow titanium powder-coated

ICONS

-  Drilling distance

Care instructions for stainless steel products

Our care instructions brochure contains practical tips for the optimal cleaning of our stainless steel handles and is enclosed with every stainless steel product.

Upon request, we can also customise the brochure with your own logo.



confurn | living solutions
Sundernkämpe 14 | D-32549 Bad Oeynhausen
Phone +49 5734 9609-0 | Fax +49 5734 9609-87
www.confurn.de | info@confurn.de

